

OGIA





MOBILIER DE BUREAU

COLLECTION OGIA

DOCUMENTATION TECHNIQUE

Tables et tables de réunion Ogi A descriptif technique



.mdd, créée en 1993 à Sępólno Krajeńskie en Pologne, est d'abord une histoire d'amitié entre Jaroslaw DABROWSKI et Zbigniew MATTYA.

Depuis l'origine, nous souhaitons incarner un modèle d'entreprise où l'humain est la première des préoccupations. Nous considérons que l'épanouissement personnel de chaque membre de notre équipe, est la clé de notre succès. Garder comme piliers des valeurs familiales participe à ce projet.

Nous créons du mobilier répondant aux besoins spécifiques des espaces de travail. Pour vous permettre de favoriser le travail collaboratif, la créativité et les échanges dans l'entreprise, nous vous proposons un mobilier design, conçu PAR et POUR l'homme. Grâce à notre politique de réinvestissement constant dans l'outil de production nous disposons d'un parc de machines modernes, permettant une fabrication de qualité. Citoyens du monde, nous agissons aujourd'hui en pensant aux générations de demain. Ainsi nous utilisons des matériaux au taux de recyclabilité proche de 95%.

Le monde du travail est en mutation constante. Nous veillons, et collaborons avec des designers et nos clients, pour anticiper et être toujours au plus près du besoin.



Informations générales :

Garantie :

Produits .mdd - 5 ans.

Composants électriques et tissus - 2 ans.

Mélaminé - certifié :



Montage :

livrée en pièces détachées

Emballage :

carton, enveloppe en plastique perforé

Conforme aux normes :

PN-EN 15372:2010

Densité du panneau :

12 mm - 690 - 750 kg/m³

18 mm - 650 - 690 kg/m³

28 mm - 610 - 630 kg/m³

36 mm - 610 - 630 kg/m³

Composition des matériaux *:

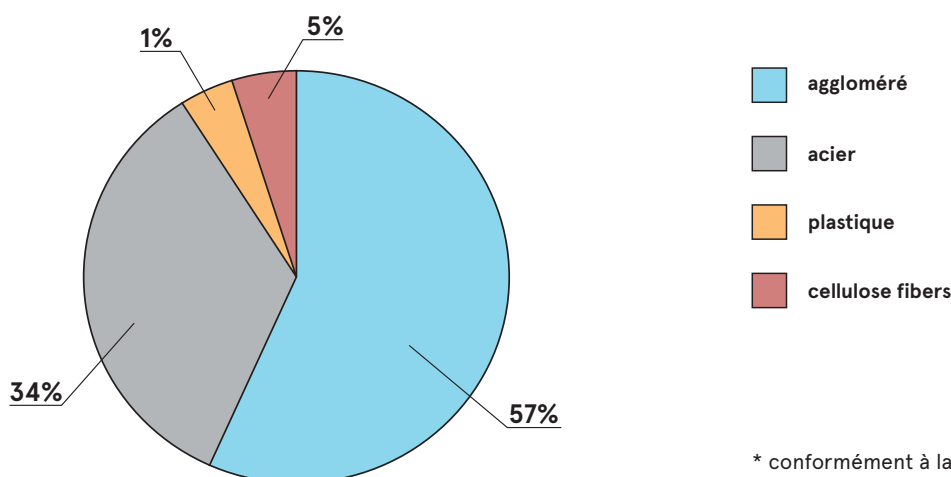

* conformément à la déclaration EPD

Tables et tables de réunion Ogi A

1. Plateau - mélaminé 28 mm, chants ABS
2. Pied - métal, finition peinture poudre époxy, profil 60x30 mm
3. Vérins de réglage - course de 5 mm

OPTION PAYANTE:

4. Top access M05
5. Mediabox M04H - 2xRJ45 (classe E, cat. 6); 1xUSB/1xHDMI/4x230V
6. Mediabox M04 - 2xRJ45 (classe E, cat. 6); + 1 x USB + 4 x 230V
7. Mediabox M06H - OPTION AVEC PLUS VALUE - 2x230V+HDMI+USB, couleur: aluminium anodisé, blanc, noir

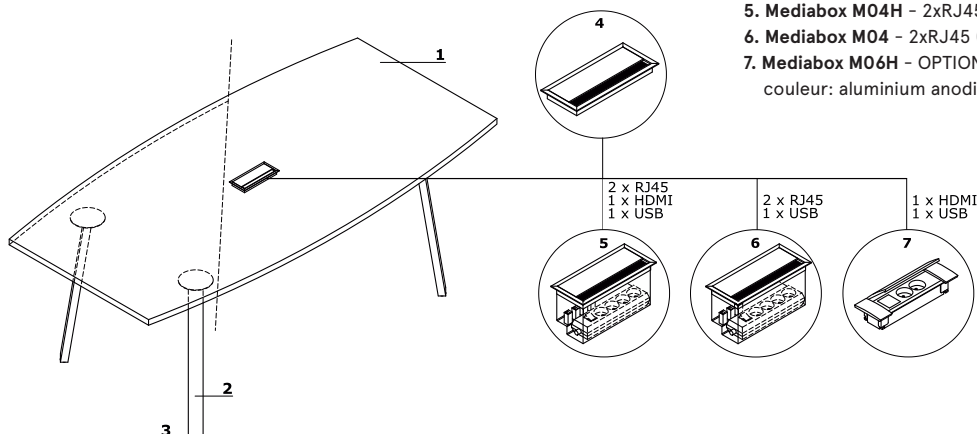

Emplacement mediabox

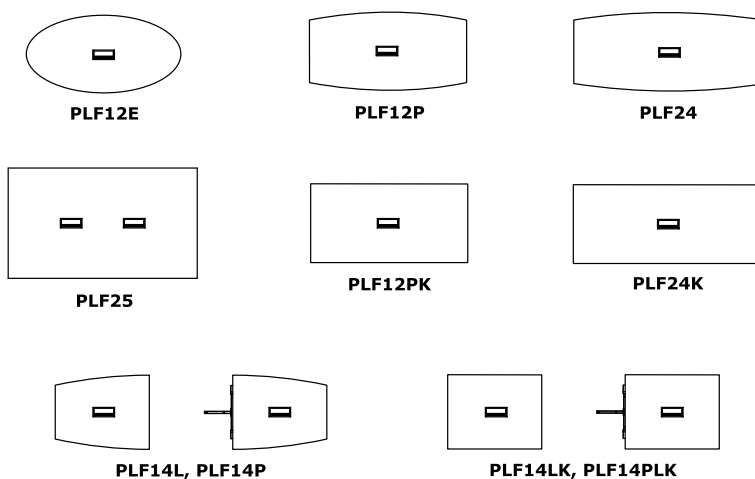

Emplacement des chaises

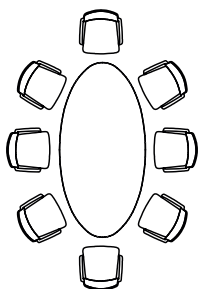

PLF12E

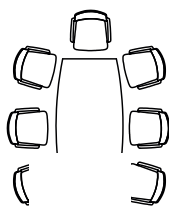

PLF12P

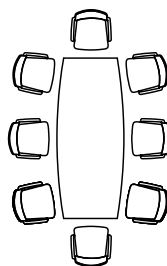

PLF24

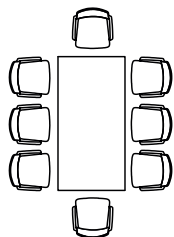

PLF12PK

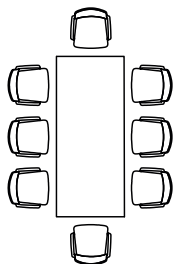

PLF24K

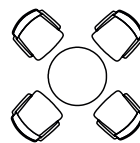

PLF80

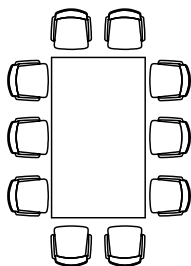

PLF25

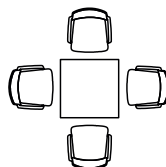

PLF81

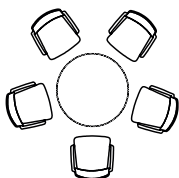

PLF10

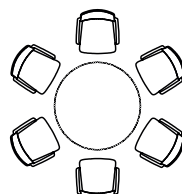

PLF11

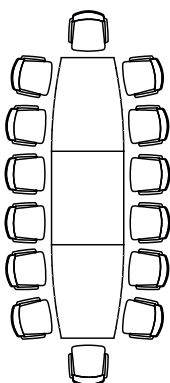

PLF14L, PLF14S,
PLF14P

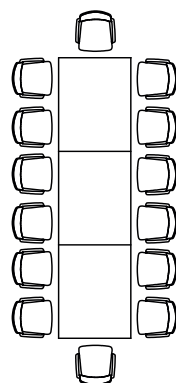

PLF14LK, PLF14S,
PLF14PK

Tables et tables de réunion Ogi A *



PLF80
800 / 800 / 740
17.1 kg



PLF10
1000 / 1000 / 740
25 kg



PLF11
1200 / 1200 / 740
33 kg



PLF12E
2000 / 1000 / 740
42 kg

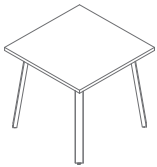

PLF81
800 / 800 / 740
21.5 kg

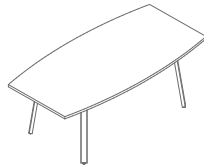

PLF12P
2000 / 800-1000 / 740
46.5 kg

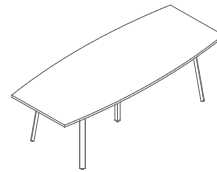

PLF24
2400 / 800-1000 / 740
58.3 kg

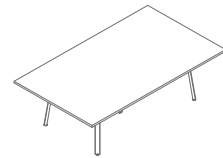

PLF25
2400 / 1400 / 740
81 kg



PLF14P
1400 / 800-1100 / 740
45 kg



PLF14S
1400 / 1100 / 740
43 kg



PLF14L
1400 / 800-1100 / 740
33.5 kg

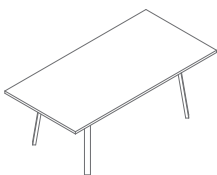

PLF12PK
2000 / 1000 / 740
48.75 kg

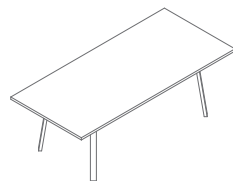

PLF24K
2400 / 1000 / 740
56.9 kg



PLF14PK
1400 / 1100 / 740
47.9 kg

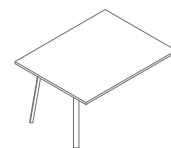

PLF14LK
1400 / 1100 / 740
36.4 kg

* Dimensions exprimées en millimètre : Largeur x Profondeur x Hauteur

| | | | |
|-----------------------------------|--------------------|---|------------|
| Tables et tables de réunion Ogi A | Date 03.01.2023 | Ces données sont valides à la date d'élaboration. Les évolutions des produits, si elles ne touchent pas les caractéristiques fondamentales, n'impliquent pas une mise à jour systématique de la fiche technique. | page 5/7 |
| | | | synoptique |

Tables et tables de réunion Ogi A *

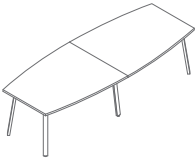

PLF18
2000 / 1100-800 / 740
78,5 kg

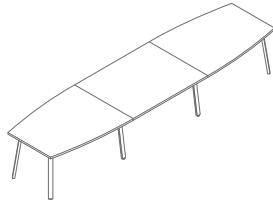

PLF19
4200 / 1100*800 / 740
121,5 kg

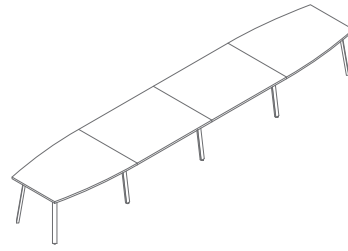

PLF20
5600 / 1100-800 / 740
164,5 kg

Tables basses Ogi A *



PLF82
800 / 800 / 550
15,6 kg



PLF60
600 / 600 / 550
11,5 kg

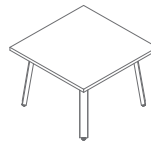

PLF83
800 / 800 / 550
19,5 kg



PLF61
600 / 600 / 550
14 kg

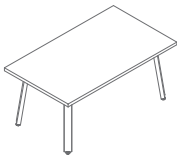

PLF17
1200 / 700 / 550
24,05 kg

Accessoires *

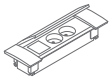

M06H
245 / 80 / 50
1 kg

* Dimensions exprimées en millimètre : Largeur x Profondeur x Hauteur

| | | | |
|--|--------------------|---|-------------------|
| Tables et tables de réunion Ogi A | Date 03.01.2023 | Ces données sont valides à la date d'élaboration. Les évolutions des produits, si elles ne touchent pas les caractéristiques fondamentales, n'impliquent pas une mise à jour systématique de la fiche technique. | page 6/7 |
| | | | synoptique |

Plateau



08 Noir



26 Aluminium
satiné



31 Chêne
canadien



39 Bouleau clair



64 Cacao

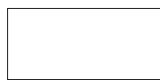

67 Blanc pastel



106 Noyer



154 Anthracite



167 Chêne gris



168 Chêne naturel



169 Chêne miel

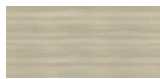

170 Acacia



171 Noyer foncé

Piètement, mediabox



M009 Aluminium
semi-mat RAL9006



M015 Blanc
semi-mat RAL9010



M154 Anthracite
semi-mat RAL7043



M115 Noir
semi-mat RAL9005



MOBILIER DE BUREAU

COLLECTION OGIA

DOCUMENTATION TECHNIQUE

Tables et tables de réunion Ogi A descriptif technique



.mdd, créée en 1993 à Sępólno Krajeńskie en Pologne, est d'abord une histoire d'amitié entre Jaroslaw DABROWSKI et Zbigniew MATTYA.

Depuis l'origine, nous souhaitons incarner un modèle d'entreprise où l'humain est la première des préoccupations. Nous considérons que l'épanouissement personnel de chaque membre de notre équipe, est la clé de notre succès. Garder comme piliers des valeurs familiales participe à ce projet.

Nous créons du mobilier répondant aux besoins spécifiques des espaces de travail. Pour vous permettre de favoriser le travail collaboratif, la créativité et les échanges dans l'entreprise, nous vous proposons un mobilier design, conçu PAR et POUR l'homme. Grâce à notre politique de réinvestissement constant dans l'outil de production nous disposons d'un parc de machines modernes, permettant une fabrication de qualité. Citoyens du monde, nous agissons aujourd'hui en pensant aux générations de demain. Ainsi nous utilisons des matériaux au taux de recyclabilité proche de 95%.

Le monde du travail est en mutation constante. Nous veillons, et collaborons avec des designers et nos clients, pour anticiper et être toujours au plus près du besoin.



Informations générales :

Garantie :

Produits .mdd - 5 ans.

Composants électriques et tissus - 2 ans.

Mélaminé - certifié :



Montage :

livrée en pièces détachées

Emballage :

carton, enveloppe en plastique perforé

Conforme aux normes :

PN-EN 15372:2010

Densité du panneau :

12 mm - 690 - 750 kg/m³

18 mm - 650 - 690 kg/m³

28 mm - 610 - 630 kg/m³

36 mm - 610 - 630 kg/m³

Composition des matériaux *:

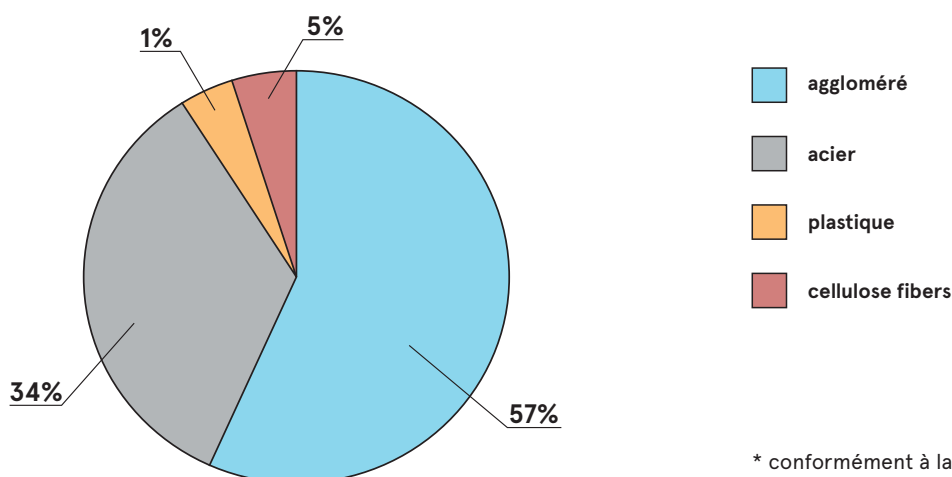

* conformément à la déclaration EPD

Tables et tables de réunion Ogi A

1. Plateau - mélaminé 28 mm, chants ABS
2. Pied - métal, finition peinture poudre époxy, profil 60x30 mm
3. Vérins de réglage - course de 5 mm

OPTION PAYANTE:

4. Top access M05
5. Mediabox M04H - 2xRJ45 (classe E, cat. 6); 1xUSB/1xHDMI/4x230V
6. Mediabox M04 - 2xRJ45 (classe E, cat. 6); + 1 x USB + 4 x 230V
7. Mediabox M06H - OPTION AVEC PLUS VALUE - 2x230V+HDMI+USB, couleur: aluminium anodisé, blanc, noir

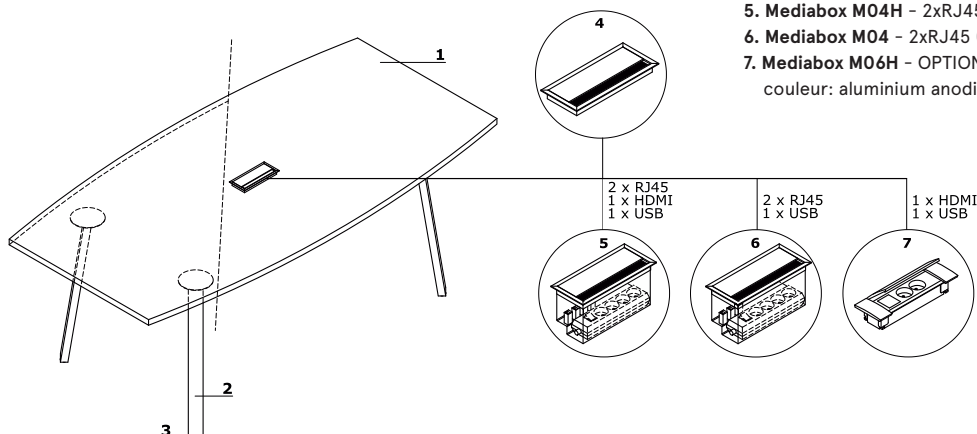

Emplacement mediabox

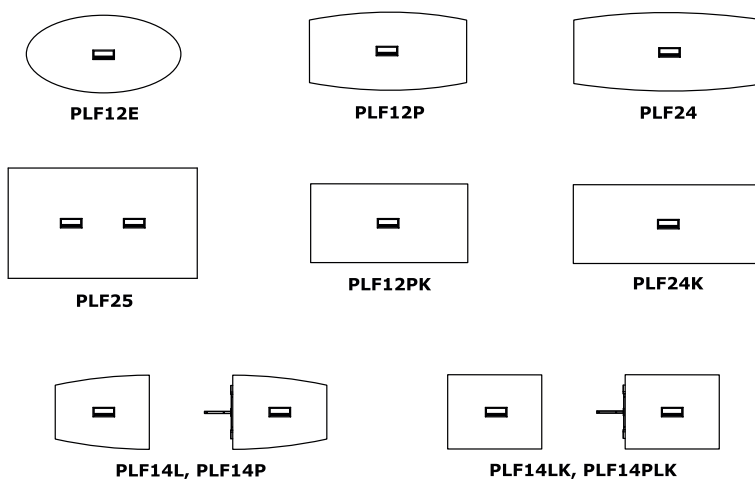

Emplacement des chaises

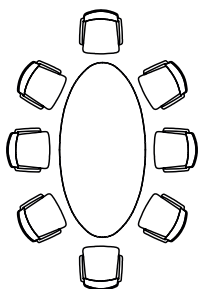

PLF12E

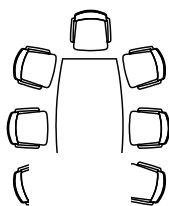

PLF12P

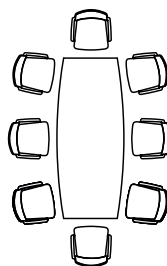

PLF24

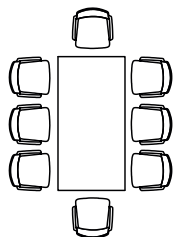

PLF12PK

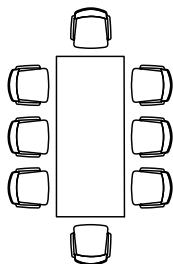

PLF24K

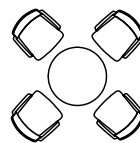

PLF80

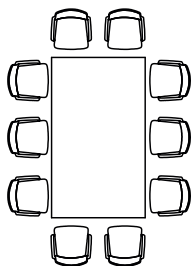

PLF25

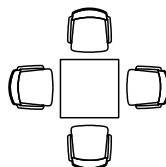

PLF81

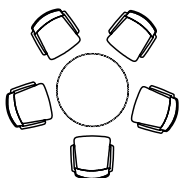

PLF10

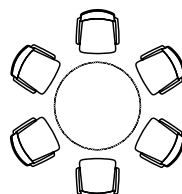

PLF11

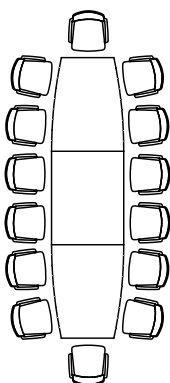

PLF14L, PLF14S,
PLF14P

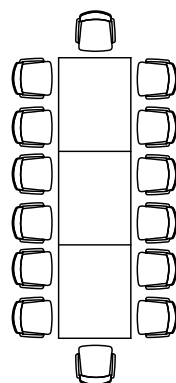

PLF14LK, PLF14S,
PLF14PK

Tables et tables de réunion Ogi A *



PLF80
800 / 800 / 740
17.1 kg



PLF10
1000 / 1000 / 740
25 kg



PLF11
1200 / 1200 / 740
33 kg

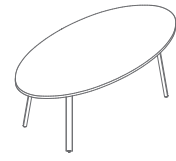

PLF12E
2000 / 1000 / 740
42 kg

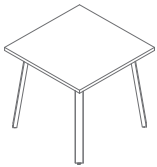

PLF81
800 / 800 / 740
21.5 kg

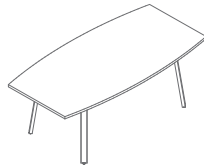

PLF12P
2000 / 800-1000 / 740
46.5 kg

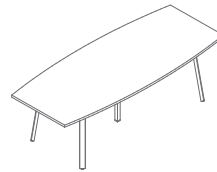

PLF24
2400 / 800-1000 / 740
58.3 kg

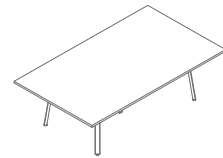

PLF25
2400 / 1400 / 740
81 kg



PLF14P
1400 / 800-1100 / 740
45 kg



PLF14S
1400 / 1100 / 740
43 kg



PLF14L
1400 / 800-1100 / 740
33.5 kg

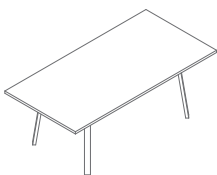

PLF12PK
2000 / 1000 / 740
48.75 kg

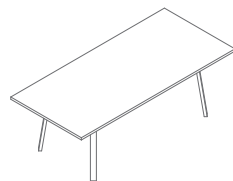

PLF24K
2400 / 1000 / 740
56.9 kg



PLF14PK
1400 / 1100 / 740
47.9 kg



PLF14LK
1400 / 1100 / 740
36.4 kg

* Dimensions exprimées en millimètre : Largeur x Profondeur x Hauteur

| | | | |
|-----------------------------------|--------------------|---|------------|
| Tables et tables de réunion Ogi A | Date 03.01.2023 | Ces données sont valides à la date d'élaboration. Les évolutions des produits, si elles ne touchent pas les caractéristiques fondamentales, n'impliquent pas une mise à jour systématique de la fiche technique. | page 5/7 |
| | | | synoptique |

Tables et tables de réunion Ogi A *

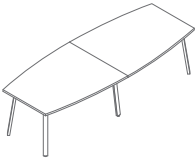

PLF18
2000 / 1100-800 / 740
78,5 kg

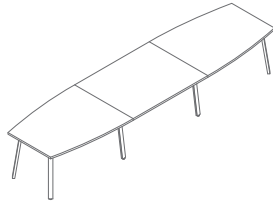

PLF19
4200 / 1100*800 / 740
121,5 kg

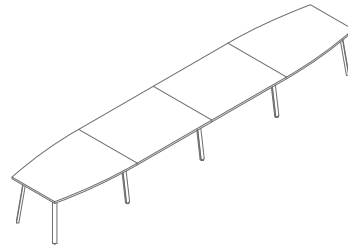

PLF20
5600 / 1100-800 / 740
164,5 kg

Tables basses Ogi A *



PLF82
800 / 800 / 550
15,6 kg



PLF60
600 / 600 / 550
11,5 kg

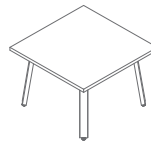

PLF83
800 / 800 / 550
19,5 kg

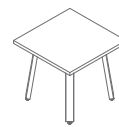

PLF61
600 / 600 / 550
14 kg

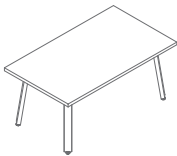

PLF17
1200 / 700 / 550
24,05 kg

Accessoires *

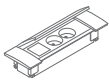

M06H
245 / 80 / 50
1 kg

* Dimensions exprimées en millimètre : Largeur x Profondeur x Hauteur

| | | | |
|--|--------------------|---|-------------------|
| Tables et tables de réunion Ogi A | Date 03.01.2023 | Ces données sont valides à la date d'élaboration. Les évolutions des produits, si elles ne touchent pas les caractéristiques fondamentales, n'impliquent pas une mise à jour systématique de la fiche technique. | page 6/7 |
| | | | synoptique |

Plateau



08 Noir



26 Aluminium
satiné



31 Chêne
canadien



39 Bouleau clair



64 Cacao



67 Blanc pastel



106 Noyer



154 Anthracite



167 Chêne gris



168 Chêne naturel



169 Chêne miel



170 Acacia



171 Noyer foncé

Piètement, mediabox



M009 Aluminium
semi-mat RAL9006



M015 Blanc
semi-mat RAL9010



M154 Anthracite
semi-mat RAL7043



M115 Noir
semi-mat RAL9005



MOBILIER DE BUREAU

COLLECTION OGIA

DOCUMENTATION TECHNIQUE

Tables et tables de réunion Ogi A descriptif technique



.mdd, créée en 1993 à Sępólno Krajeńskie en Pologne, est d'abord une histoire d'amitié entre Jaroslaw DABROWSKI et Zbigniew MATTYA.

Depuis l'origine, nous souhaitons incarner un modèle d'entreprise où l'humain est la première des préoccupations. Nous considérons que l'épanouissement personnel de chaque membre de notre équipe, est la clé de notre succès. Garder comme piliers des valeurs familiales participe à ce projet.

Nous créons du mobilier répondant aux besoins spécifiques des espaces de travail. Pour vous permettre de favoriser le travail collaboratif, la créativité et les échanges dans l'entreprise, nous vous proposons un mobilier design, conçu PAR et POUR l'homme. Grâce à notre politique de réinvestissement constant dans l'outil de production nous disposons d'un parc de machines modernes, permettant une fabrication de qualité. Citoyens du monde, nous agissons aujourd'hui en pensant aux générations de demain. Ainsi nous utilisons des matériaux au taux de recyclabilité proche de 95%.

Le monde du travail est en mutation constante. Nous veillons, et collaborons avec des designers et nos clients, pour anticiper et être toujours au plus près du besoin.



Informations générales :

Garantie :

Produits .mdd - 5 ans.

Composants électriques et tissus - 2 ans.

Mélaminé - certifié :



Montage :

livrée en pièces détachées

Emballage :

carton, enveloppe en plastique perforé

Conforme aux normes :

PN-EN 15372:2010

Densité du panneau :

12 mm - 690 - 750 kg/m³

18 mm - 650 - 690 kg/m³

28 mm - 610 - 630 kg/m³

36 mm - 610 - 630 kg/m³

Composition des matériaux *:

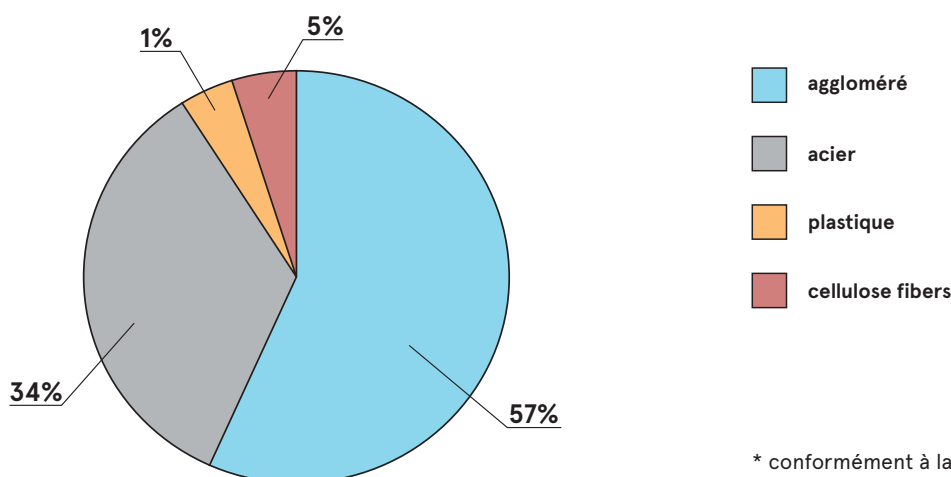

* conformément à la déclaration EPD

Tables et tables de réunion Ogi A

1. Plateau - mélaminé 28 mm, chants ABS
2. Pied - métal, finition peinture poudre époxy, profil 60x30 mm
3. Vérins de réglage - course de 5 mm

OPTION PAYANTE:

4. Top access M05
5. Mediabox M04H - 2xRJ45 (classe E, cat. 6); 1xUSB/1xHDMI/4x230V
6. Mediabox M04 - 2xRJ45 (classe E, cat. 6); + 1 x USB + 4 x 230V
7. Mediabox M06H - OPTION AVEC PLUS VALUE - 2x230V+HDMI+USB, couleur: aluminium anodisé, blanc, noir

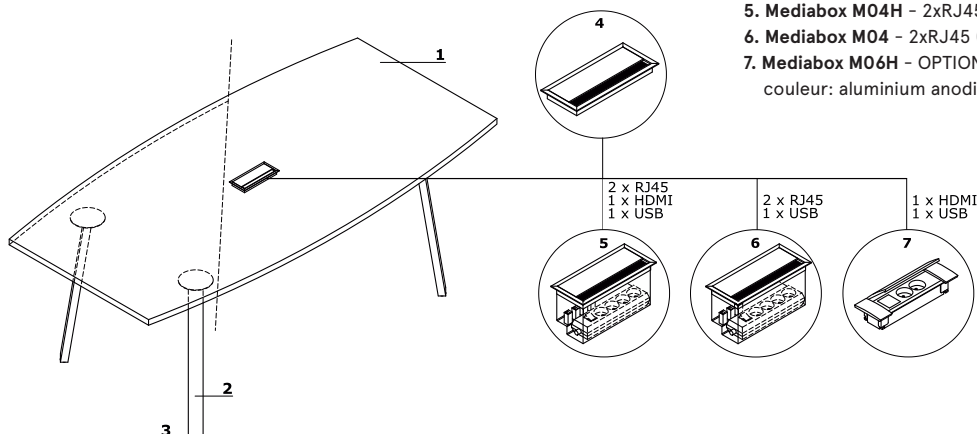

Emplacement mediabox

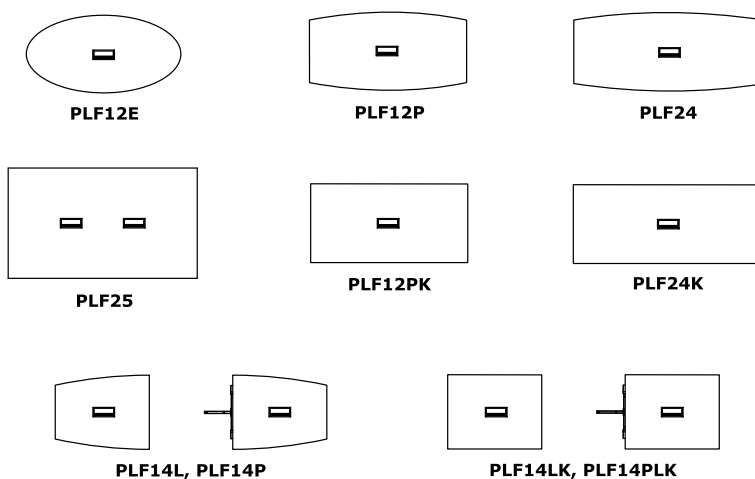

Emplacement des chaises

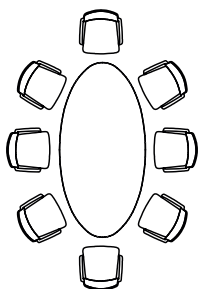

PLF12E

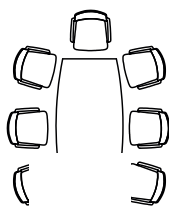

PLF12P

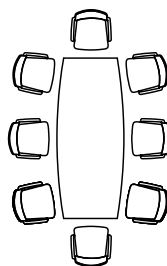

PLF24

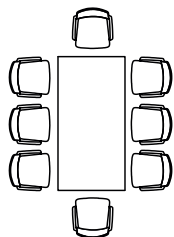

PLF12PK

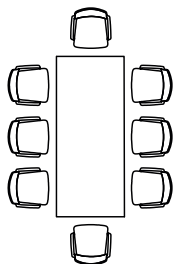

PLF24K

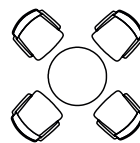

PLF80

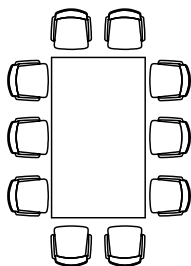

PLF25

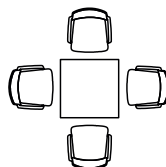

PLF81

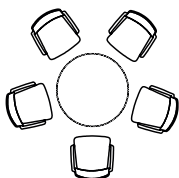

PLF10

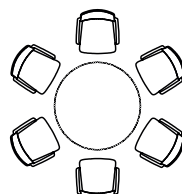

PLF11

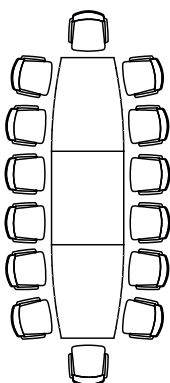

PLF14L, PLF14S,
PLF14P

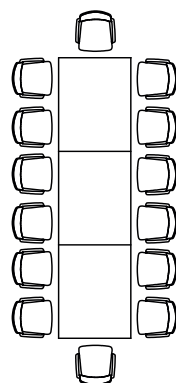

PLF14LK, PLF14S,
PLF14PK

Tables et tables de réunion Ogi A *



PLF80
800 / 800 / 740
17.1 kg



PLF10
1000 / 1000 / 740
25 kg



PLF11
1200 / 1200 / 740
33 kg



PLF12E
2000 / 1000 / 740
42 kg

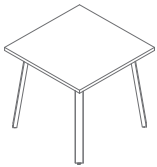

PLF81
800 / 800 / 740
21.5 kg

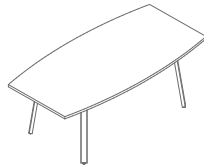

PLF12P
2000 / 800-1000 / 740
46.5 kg

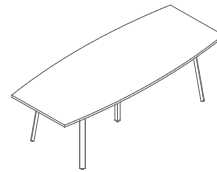

PLF24
2400 / 800-1000 / 740
58.3 kg

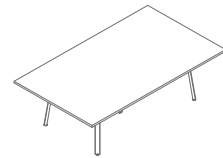

PLF25
2400 / 1400 / 740
81 kg



PLF14P
1400 / 800-1100 / 740
45 kg



PLF14S
1400 / 1100 / 740
43 kg



PLF14L
1400 / 800-1100 / 740
33.5 kg

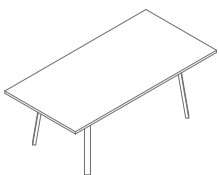

PLF12PK
2000 / 1000 / 740
48.75 kg

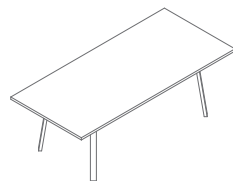

PLF24K
2400 / 1000 / 740
56.9 kg



PLF14PK
1400 / 1100 / 740
47.9 kg

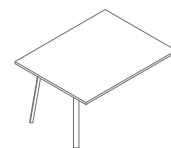

PLF14LK
1400 / 1100 / 740
36.4 kg

* Dimensions exprimées en millimètre : Largeur x Profondeur x Hauteur

| | | | |
|-----------------------------------|--------------------|---|------------|
| Tables et tables de réunion Ogi A | Date 03.01.2023 | Ces données sont valides à la date d'élaboration. Les évolutions des produits, si elles ne touchent pas les caractéristiques fondamentales, n'impliquent pas une mise à jour systématique de la fiche technique. | page 5/7 |
| | | | synoptique |

Tables et tables de réunion Ogi A *

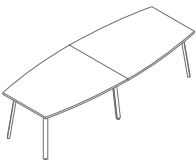

PLF18
2000 / 1100-800 / 740
78,5 kg

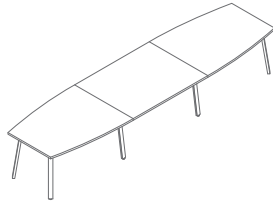

PLF19
4200 / 1100*800 / 740
121,5 kg

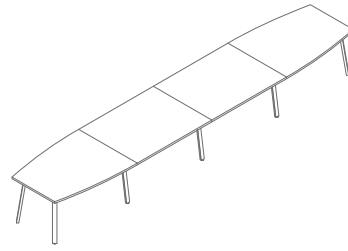

PLF20
5600 / 1100-800 / 740
164,5 kg

Tables basses Ogi A *



PLF82
800 / 800 / 550
15,6 kg



PLF60
600 / 600 / 550
11,5 kg

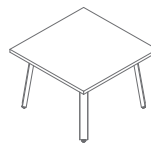

PLF83
800 / 800 / 550
19,5 kg



PLF61
600 / 600 / 550
14 kg

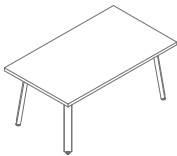

PLF17
1200 / 700 / 550
24,05 kg

Accessoires *

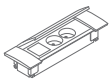

M06H
245 / 80 / 50
1 kg

* Dimensions exprimées en millimètre : Largeur x Profondeur x Hauteur

| | | | |
|--|--------------------|---|-------------------|
| Tables et tables de réunion Ogi A | Date 03.01.2023 | Ces données sont valides à la date d'élaboration. Les évolutions des produits, si elles ne touchent pas les caractéristiques fondamentales, n'impliquent pas une mise à jour systématique de la fiche technique. | page 6/7 |
| | | | synoptique |

Plateau



08 Noir



26 Aluminium
satiné



31 Chêne
canadien



39 Bouleau clair



64 Cacao



67 Blanc pastel



106 Noyer



154 Anthracite



167 Chêne gris



168 Chêne naturel



169 Chêne miel

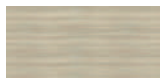

170 Acacia



171 Noyer foncé

Piètement, mediabox



M009 Aluminium
semi-mat RAL9006



M015 Blanc
semi-mat RAL9010



M154 Anthracite
semi-mat RAL7043



M115 Noir
semi-mat RAL9005



MOBILIER DE BUREAU

COLLECTION OGIA

DOCUMENTATION TECHNIQUE